

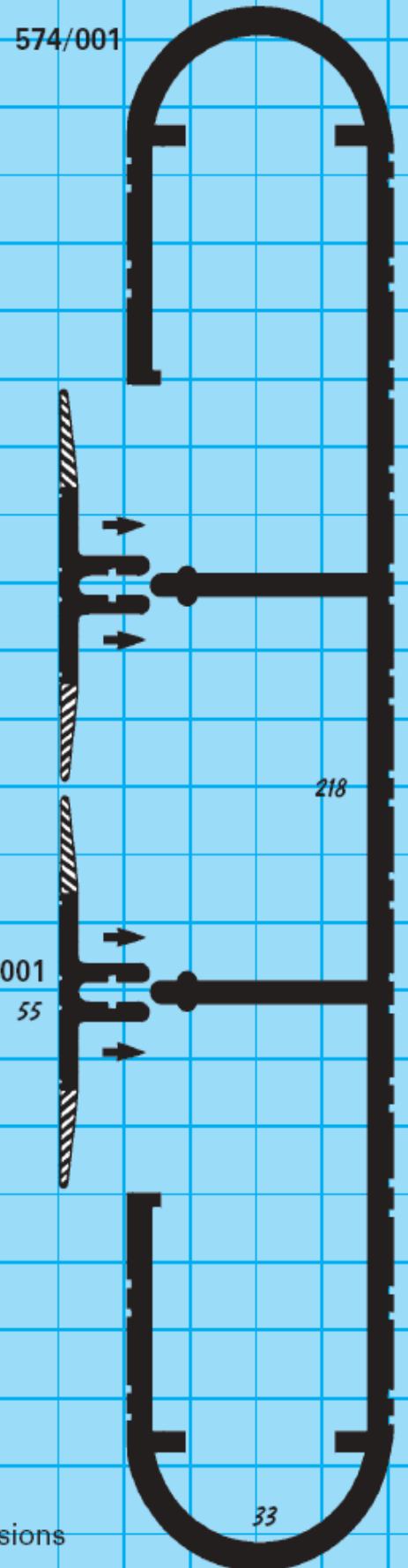

CUSTOM PROFILES (See reverse for more profile shapes)

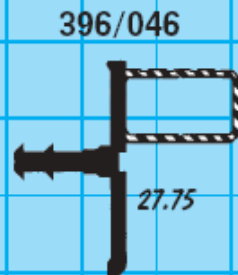

Denotes Flexible part of Dual Hardness Extrusions

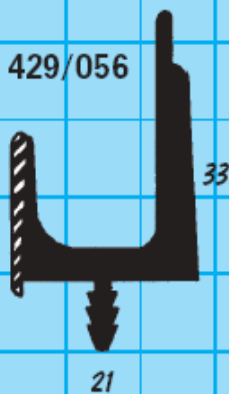
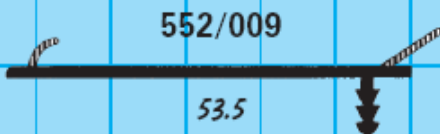
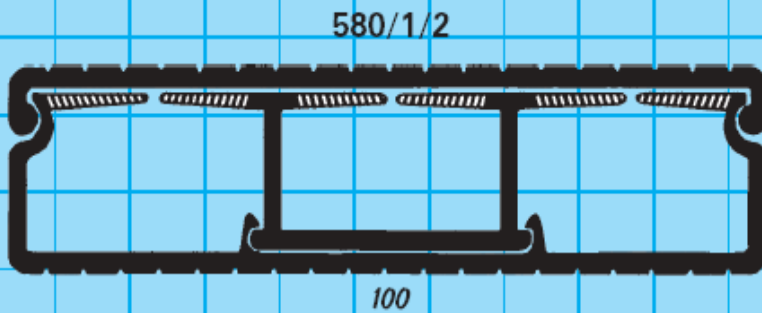
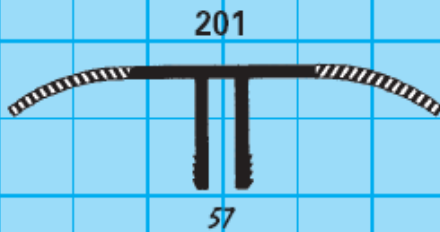
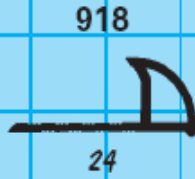
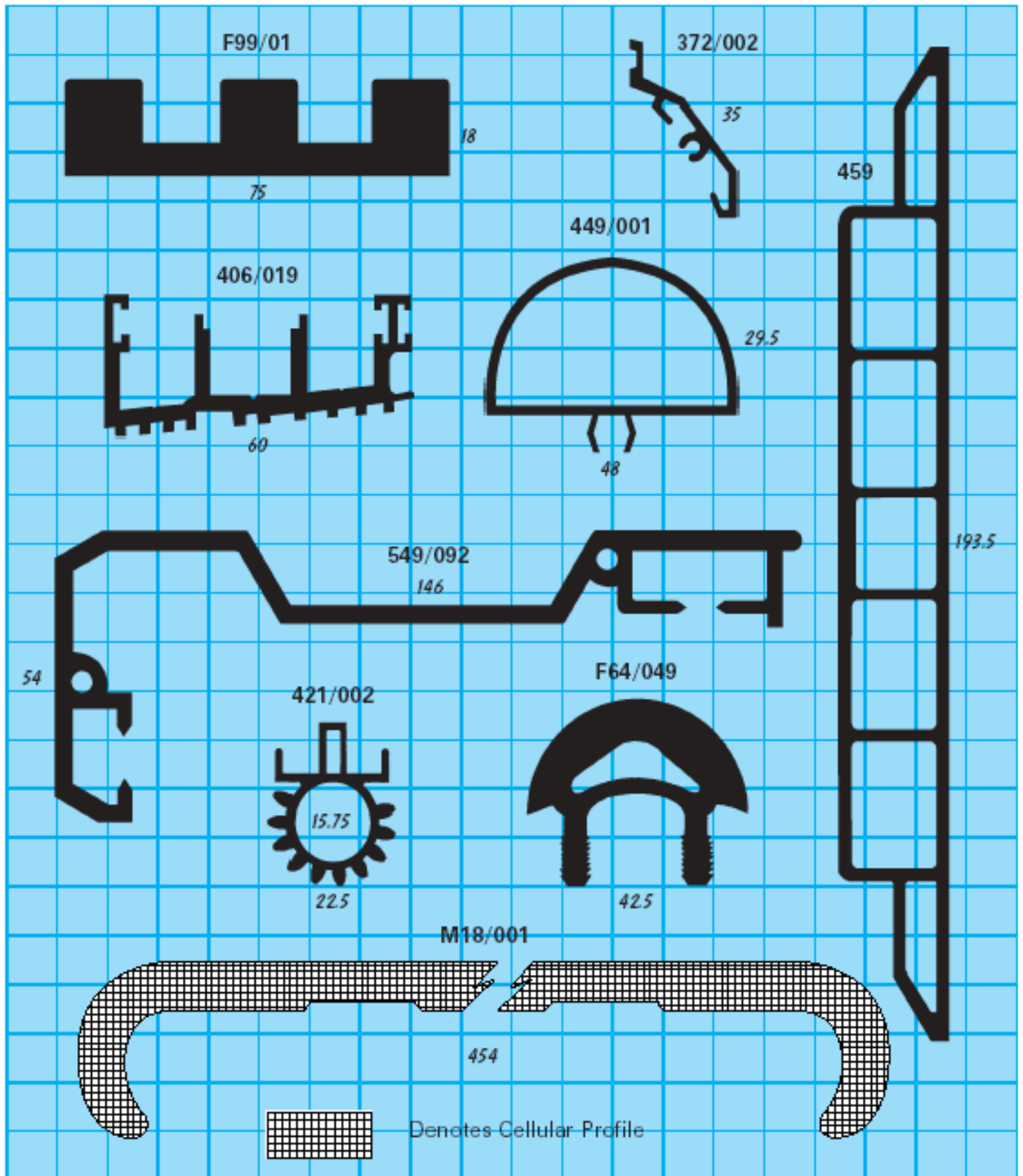

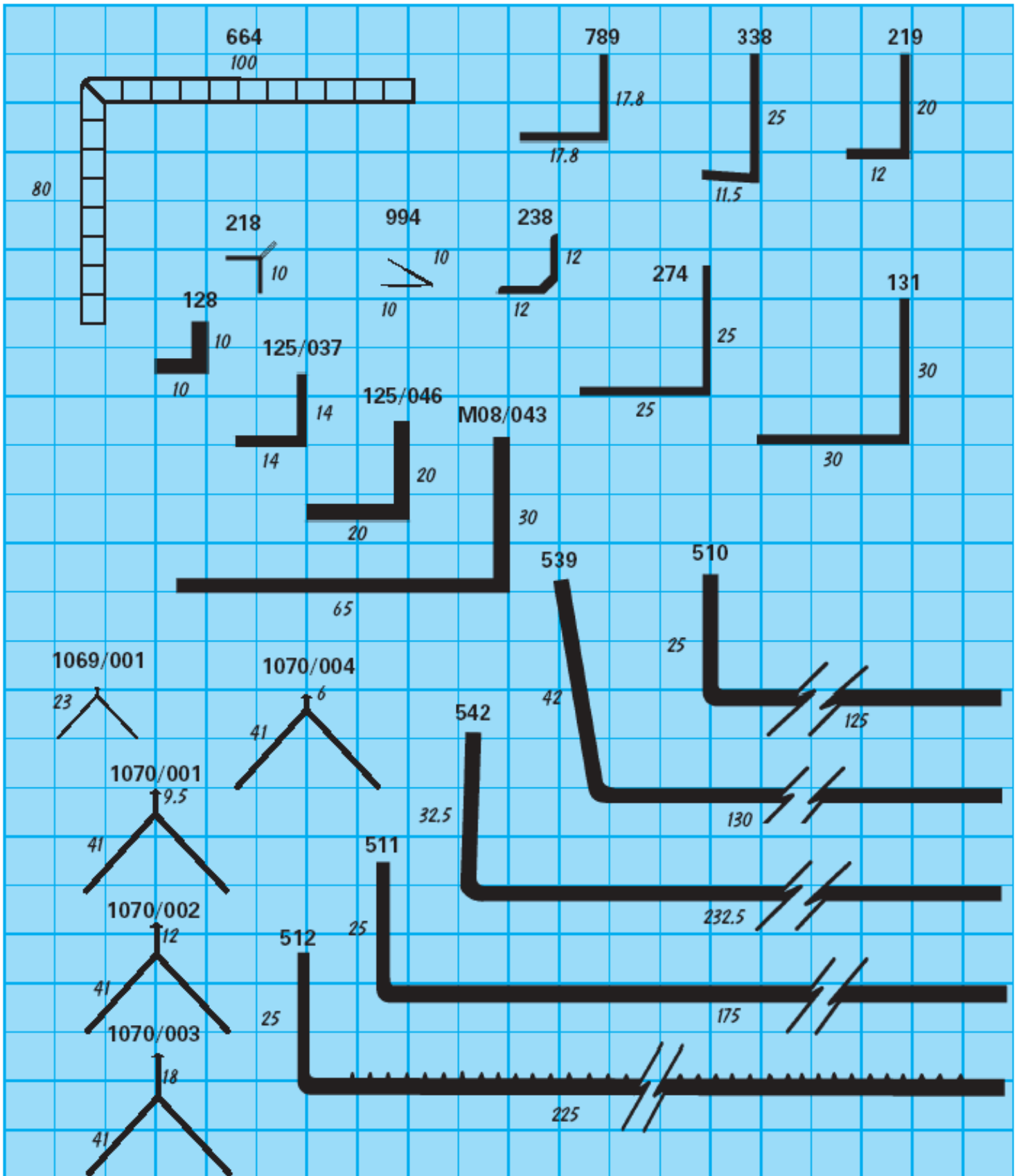

These illustrations show only part of our range, which is being added to all the time. Some shapes are customer-owned and could not be used without prior consent from that customer. All dimensions are in mm and are representative of actual size. Some profiles can be produced in dimensions other than those shown. Prefix 'F' and 'G' denotes flexible profile.

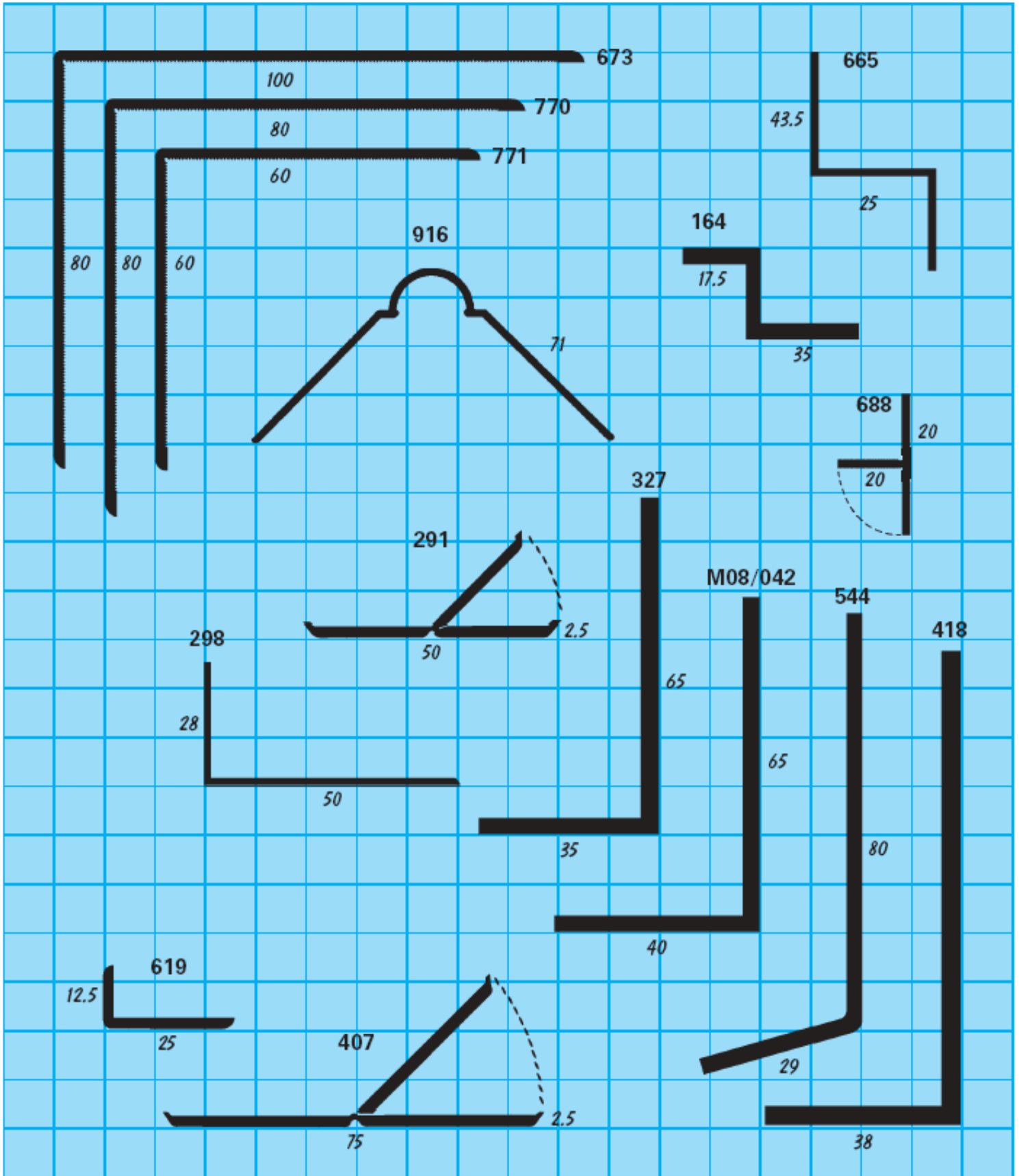



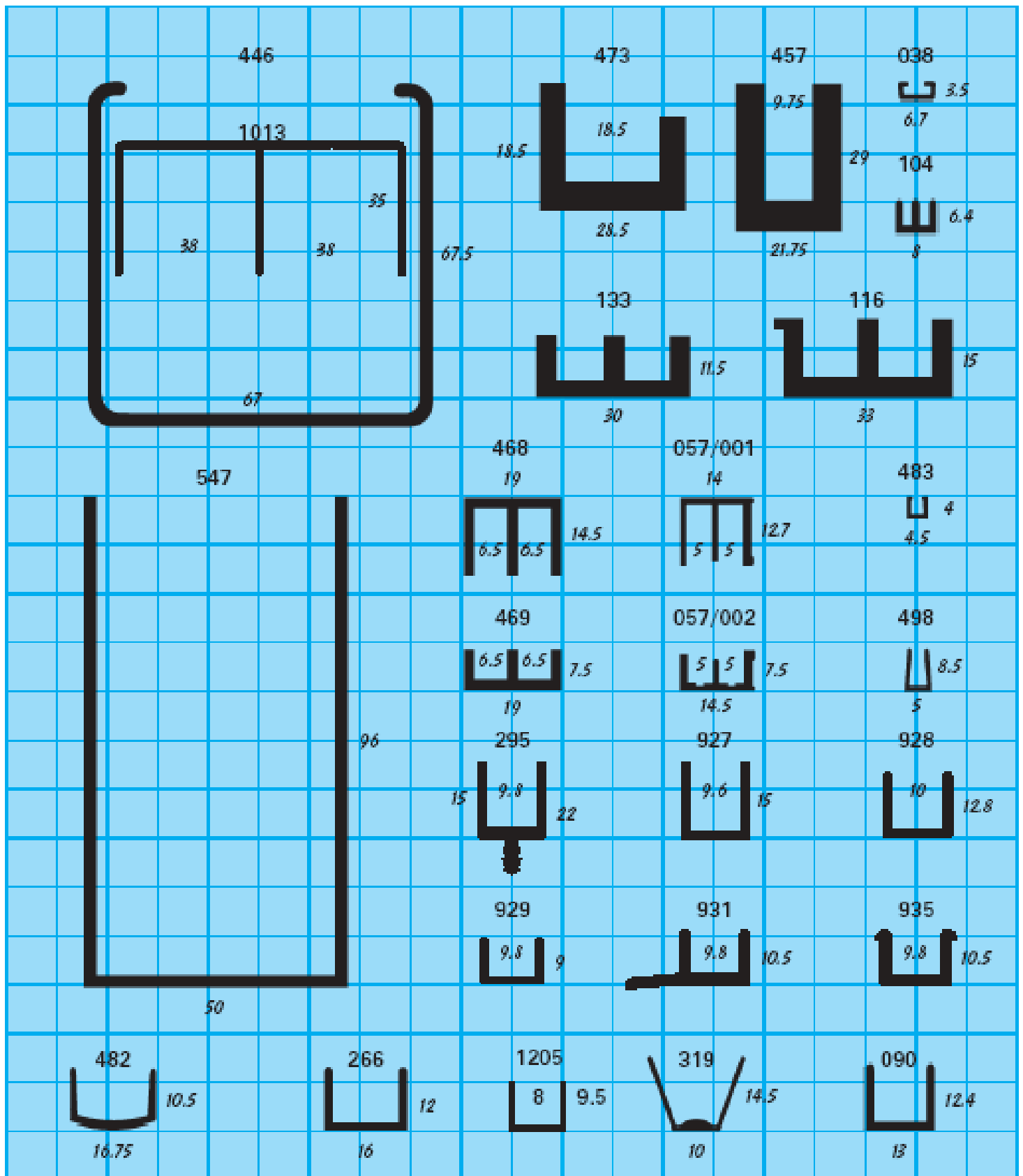

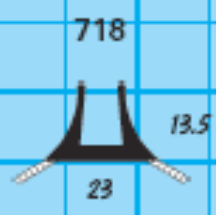
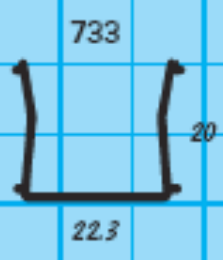
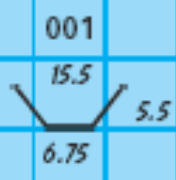
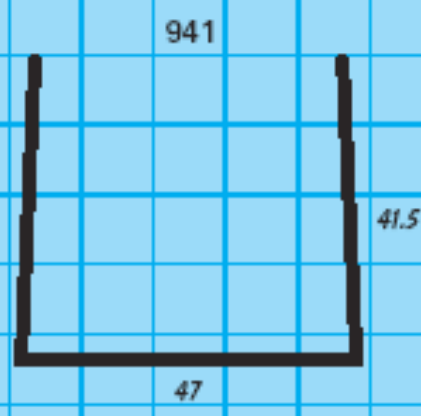
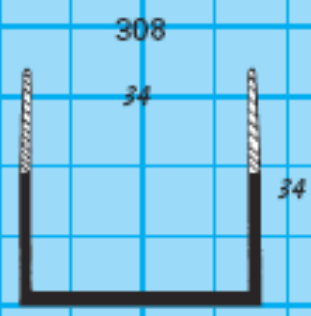
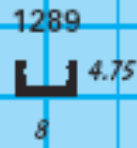
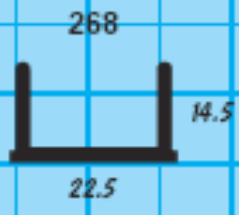
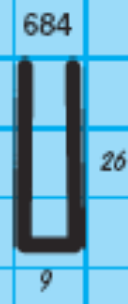
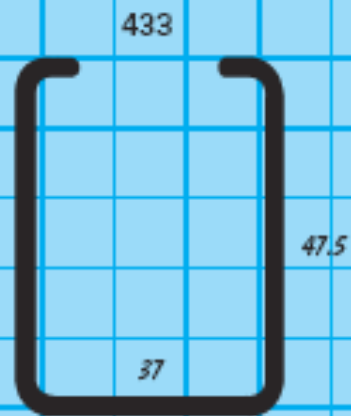
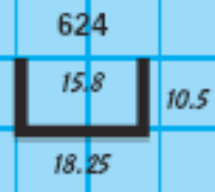









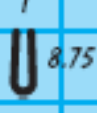
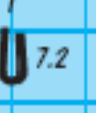
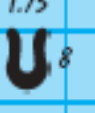
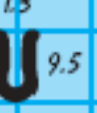
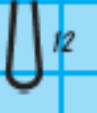
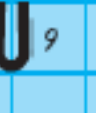
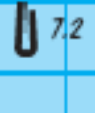

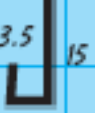
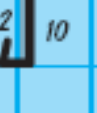

These illustrations show only part of our range, which is being added to all the time. Some shapes are customer-owned and could not be used without prior consent from that customer. All dimensions are in mm and are representative of actual size. Some profiles can be produced in dimensions other than those shown. Prefix 'F' and 'G' denotes flexible profile.



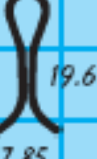
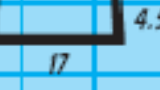

Denotes Flexible part of Dual Hardness Extrusions

912 	951 	F20 	212 	463 
442 	345/007 	345/076 	613/001 	388 
	346/003 	F76 	345/004 	346/042 
217 		215/001 	152 	215/003 
220 	056 	F52 	F03 	
143 	687 	026/006 	026/007 	

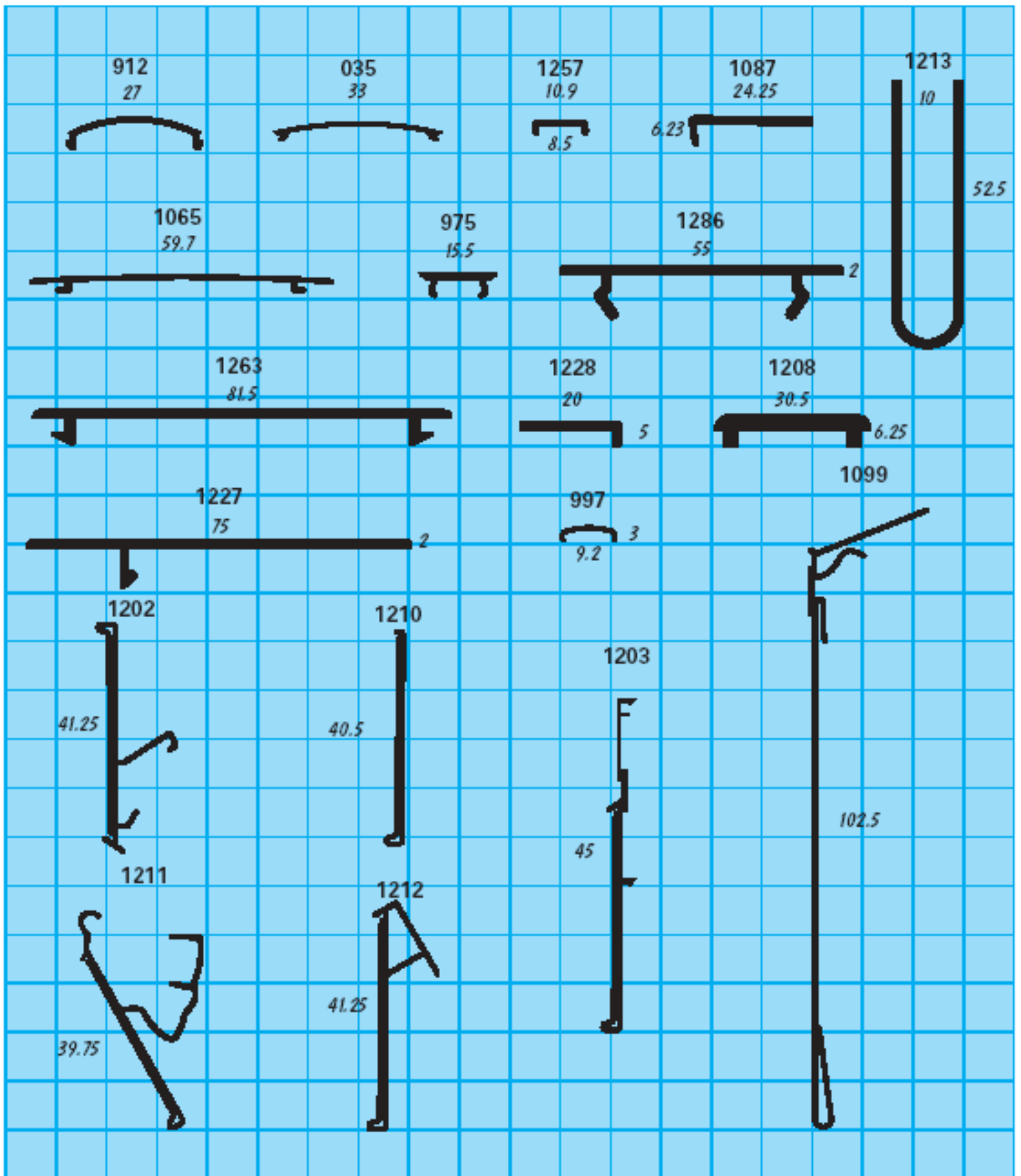

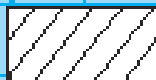
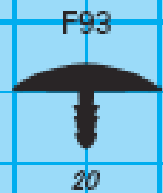
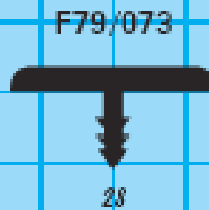
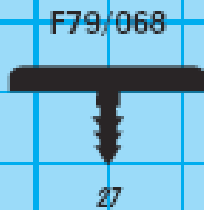
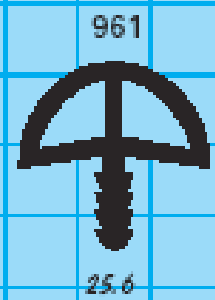
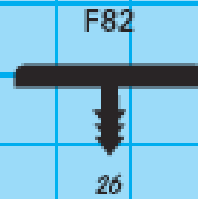
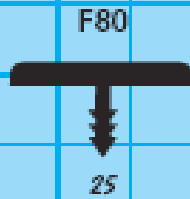
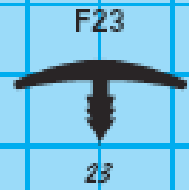
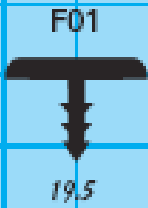

Denotes Flexible part of Dual Hardness Extrusions

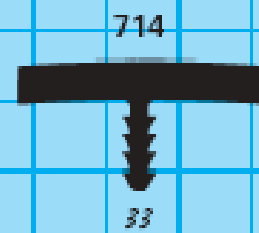
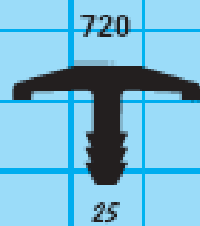
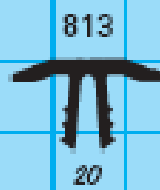
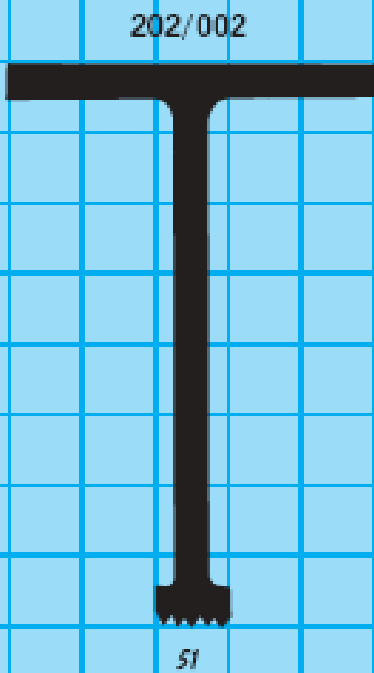
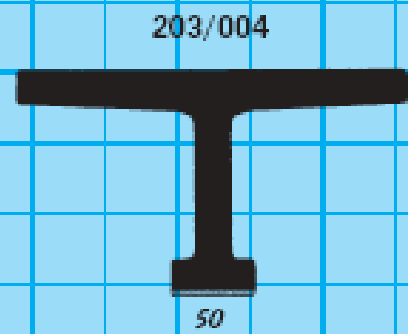
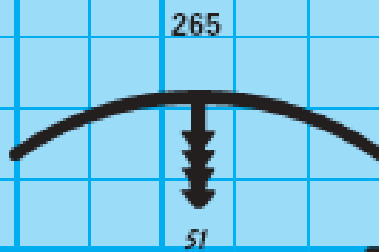
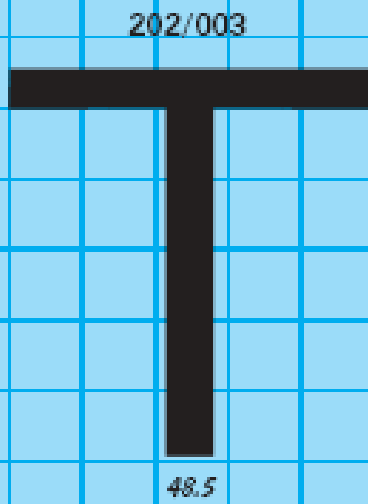
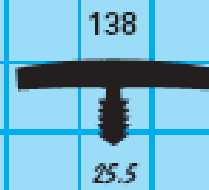
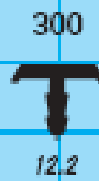
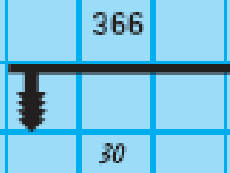

STRIPS/SOLID PROFILES

(See reverse for Flexible 'Panel Joints')

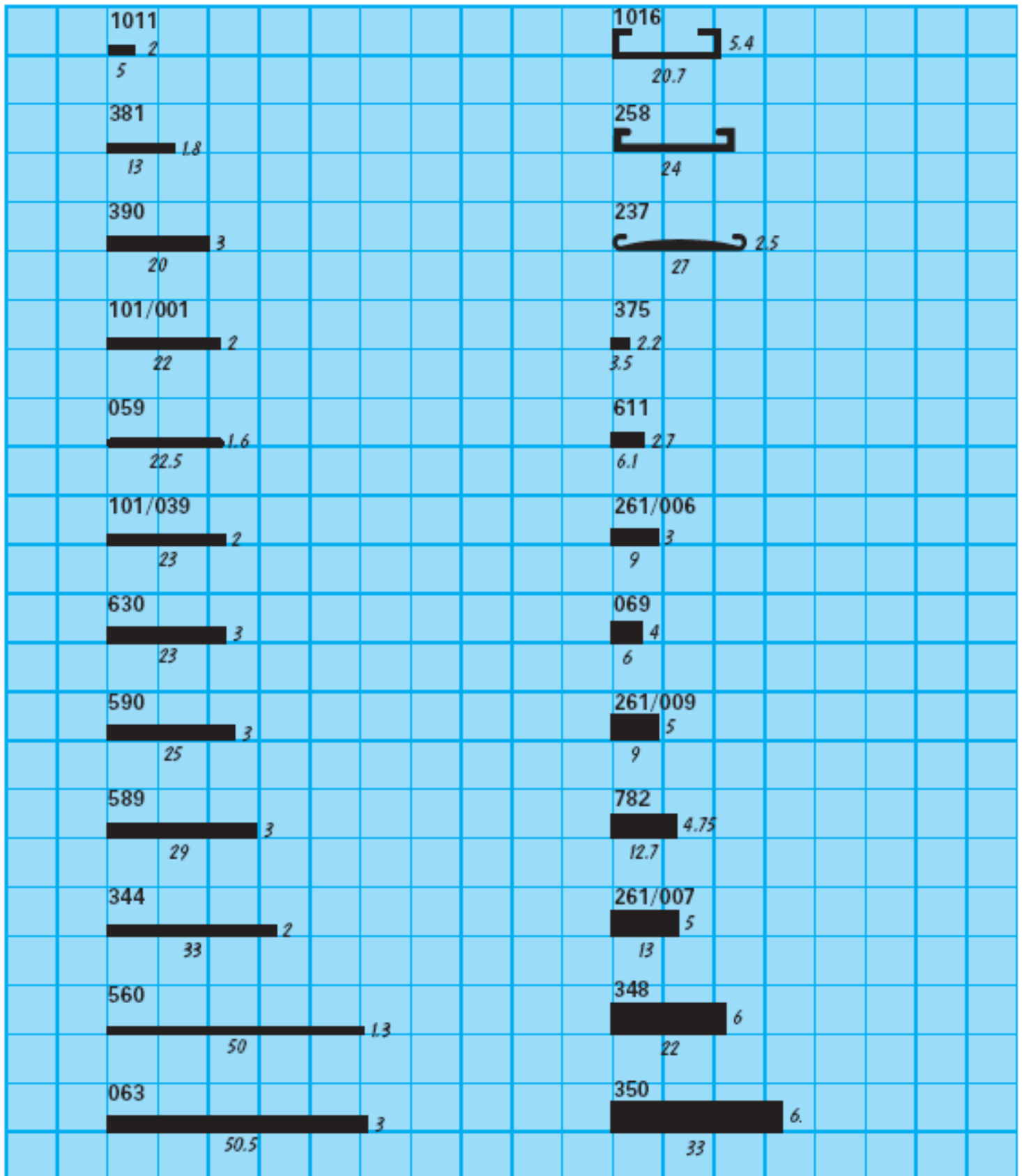

The following table lists the panel joint profiles shown in the image, including their identification numbers and associated dimensions:

Profile Number	Dimensions
007	4
006	5
085	5
618	10.6
091	15
486	19
950	4
475	21
616	10.6, 10.6
617	10.6, 10.6
326	10
601	11.7, 11.7
60	20, 4
1082	24.8
643	17
210	4.6
761	15.8, 15.1
942	10
555	8.2
1044	7.8, 16.8
1005	16
1288	1.68
1222	15.5
1259	3

 Denotes Flexible part of Dual Hardness Extrusions

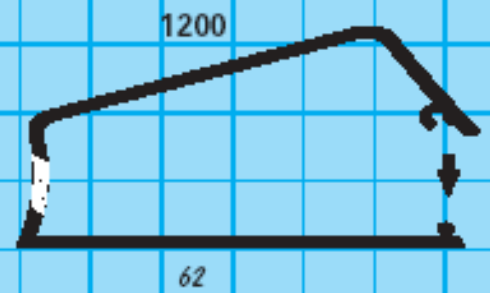
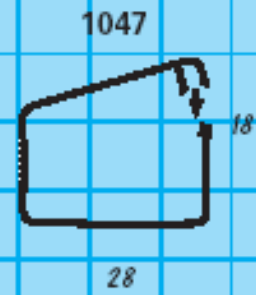
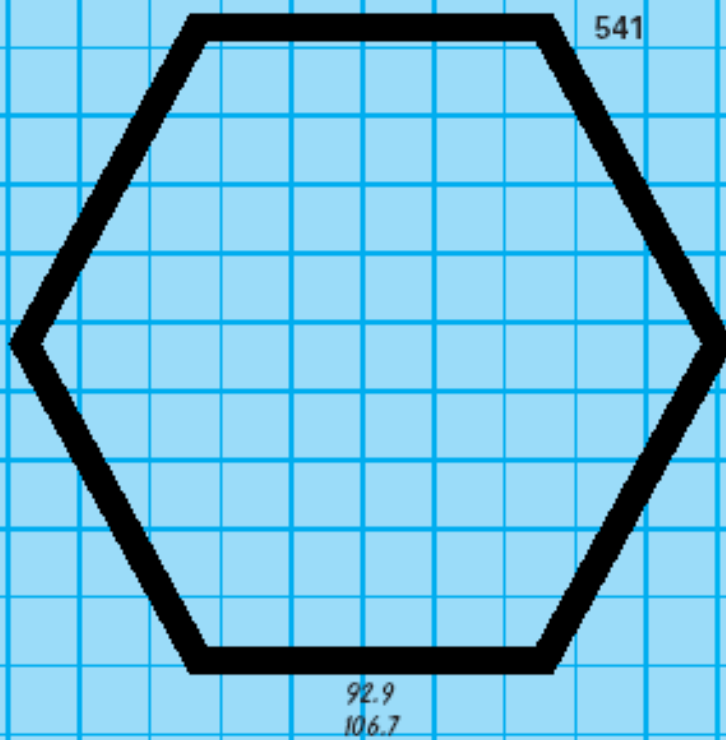
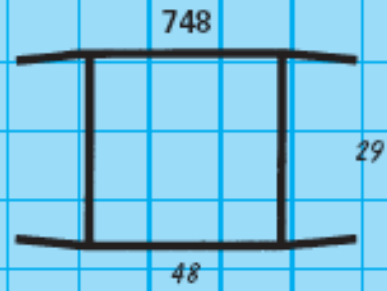
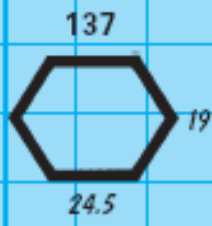
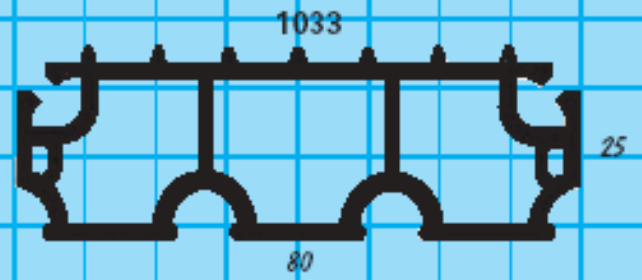
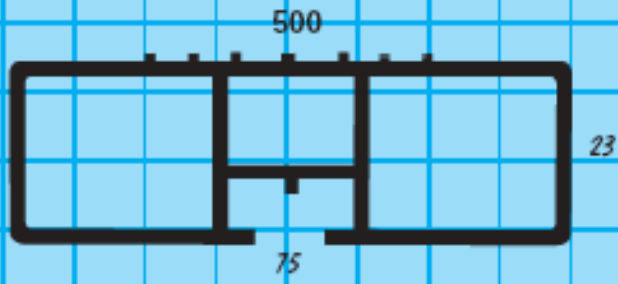

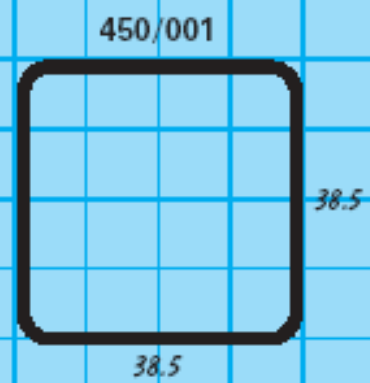
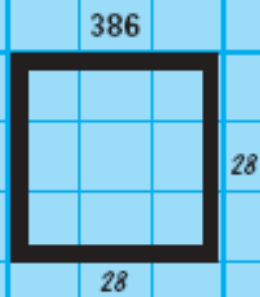
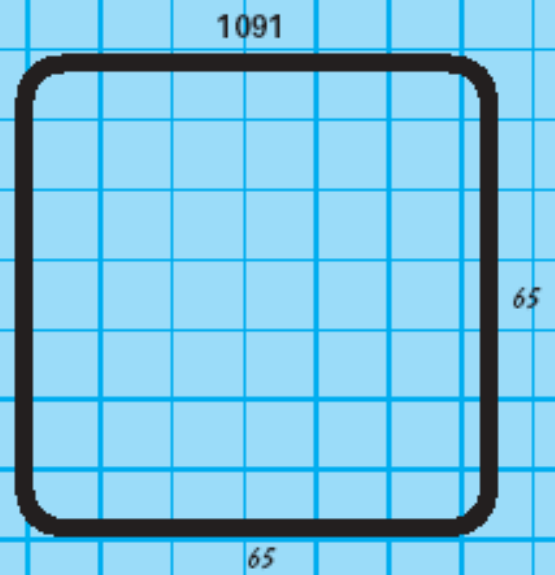
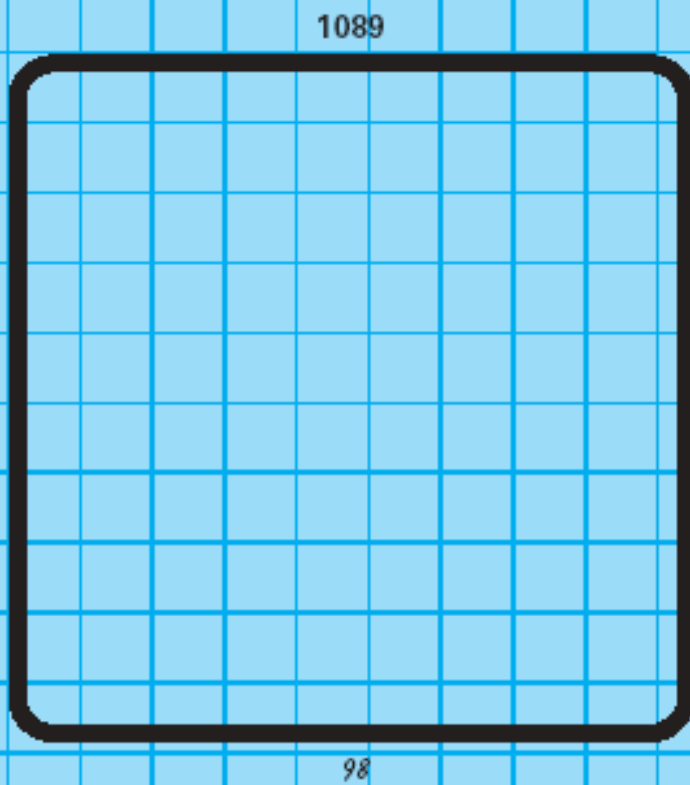
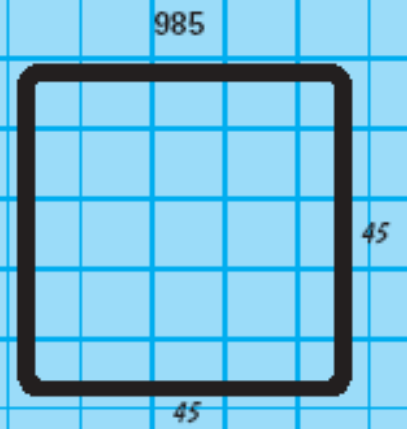
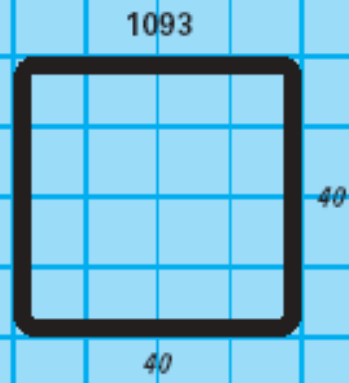
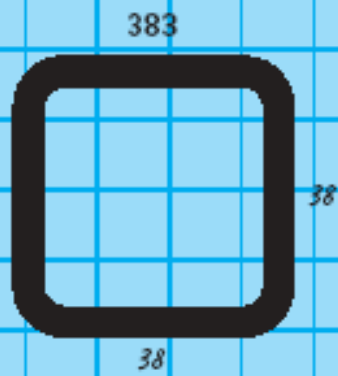

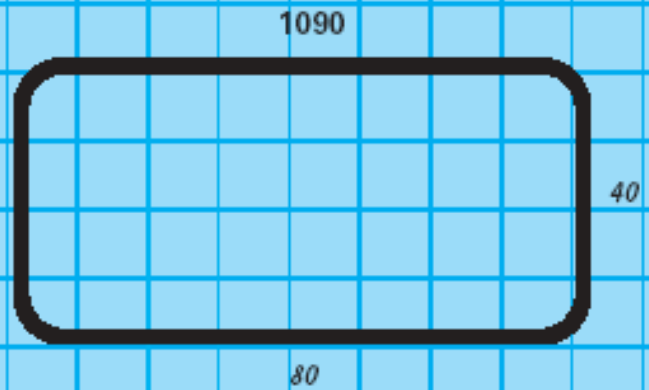
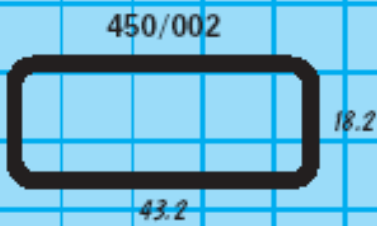
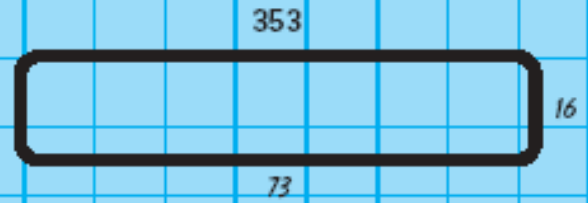
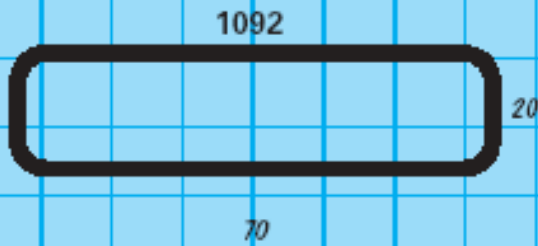
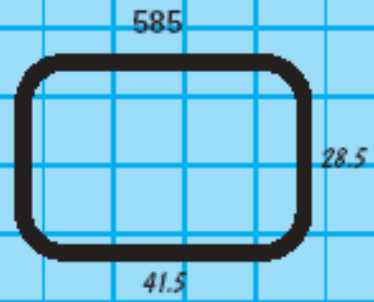
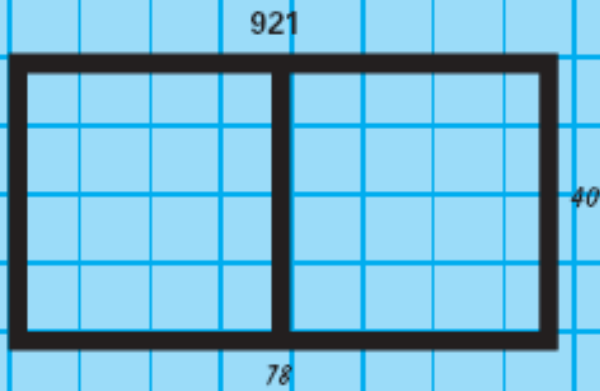

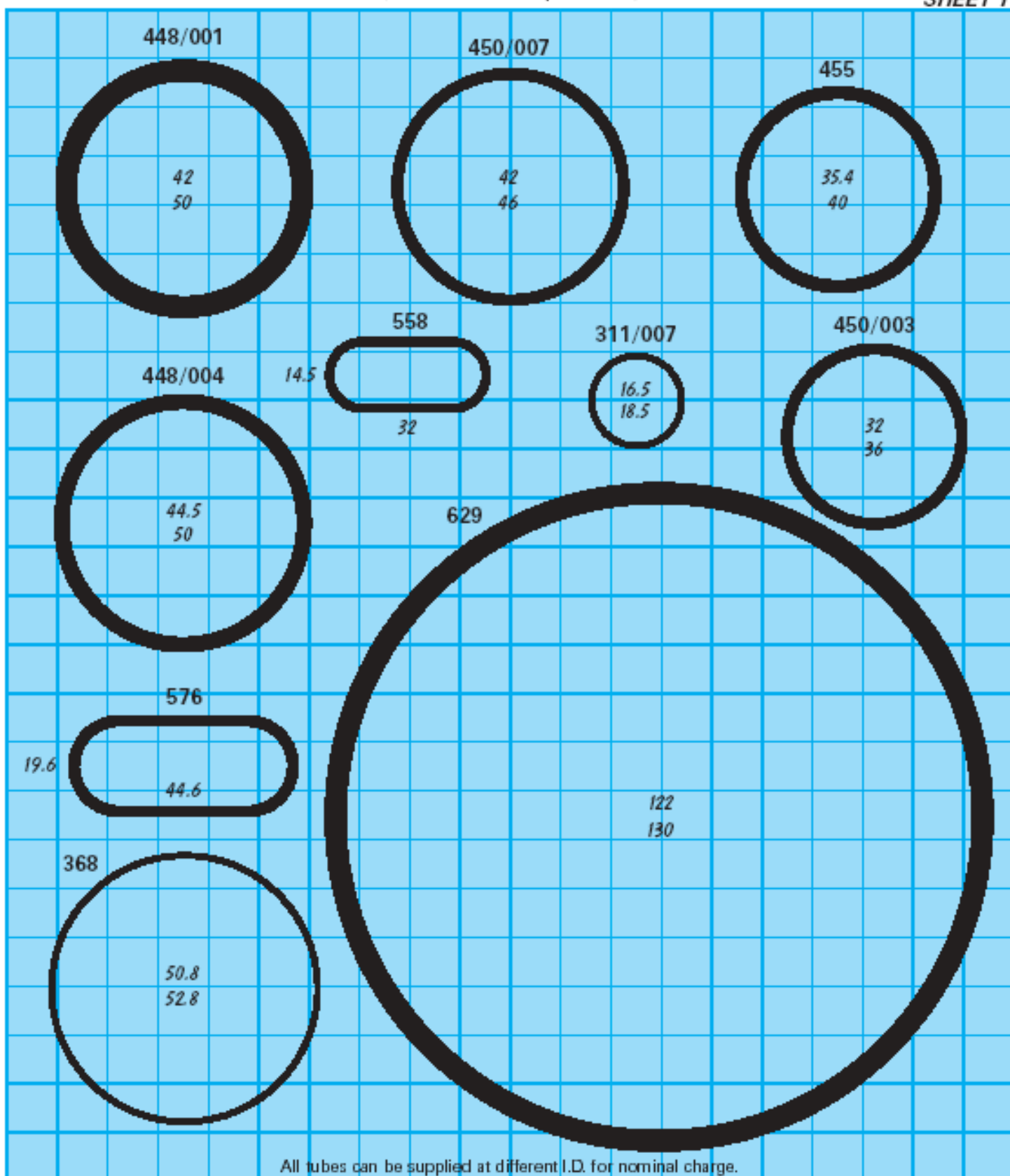

All tubes can be supplied at different I.D. for nominal charge.

365/002



625/001



311/006



352



311/011



311/009



311/002



037



311/003



309/001



All tubes can be supplied at different I.D. for nominal charge.

467



311/005



117



311/010



318



315



311/017



311/012



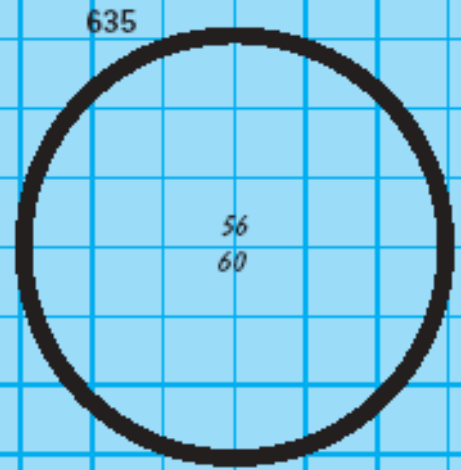
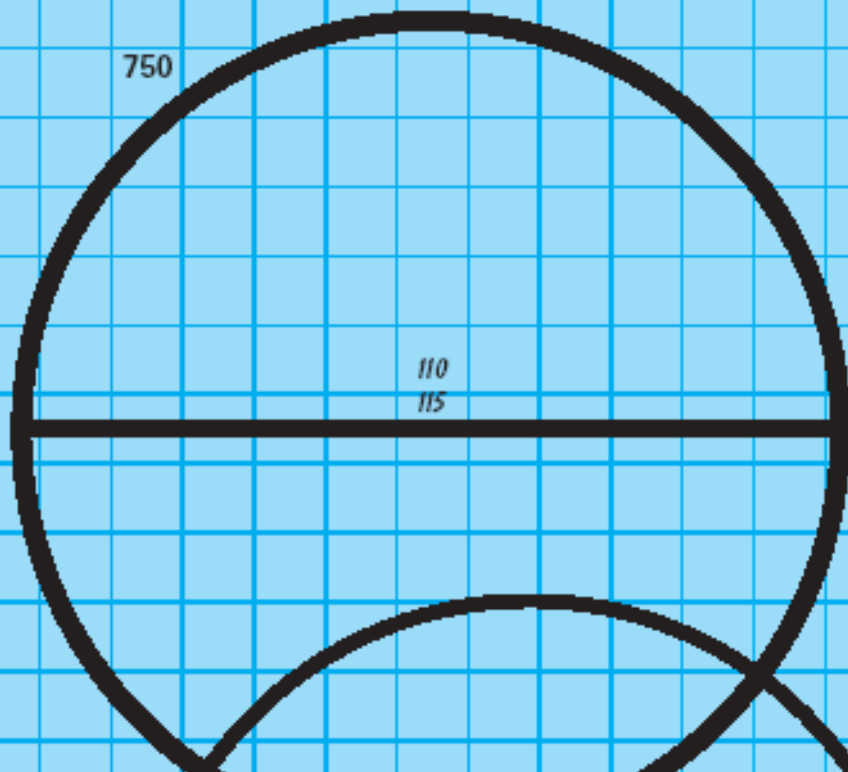

All tubes can be supplied at different I.D. for nominal charge.

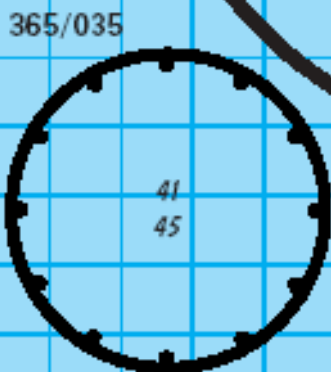
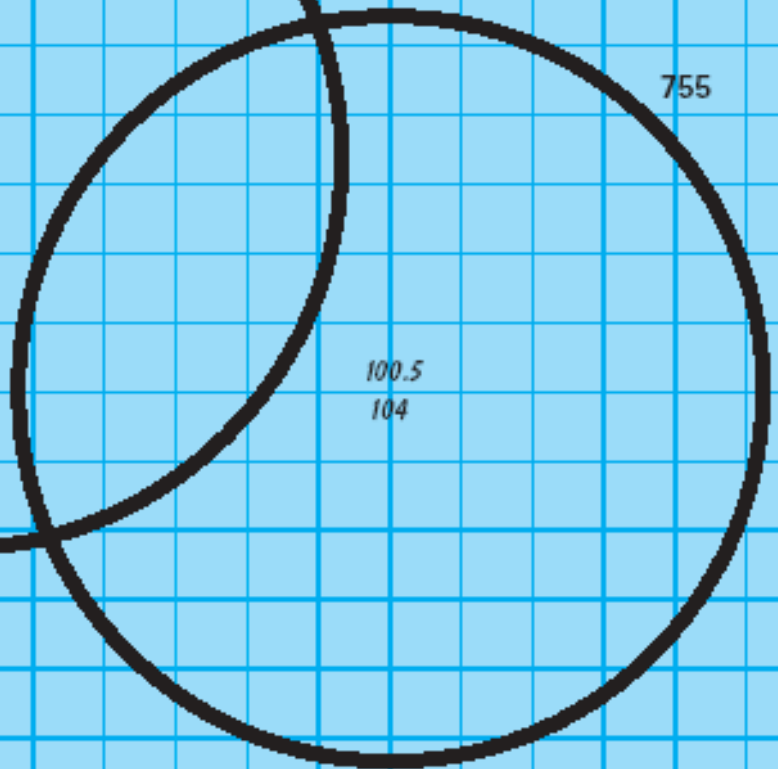
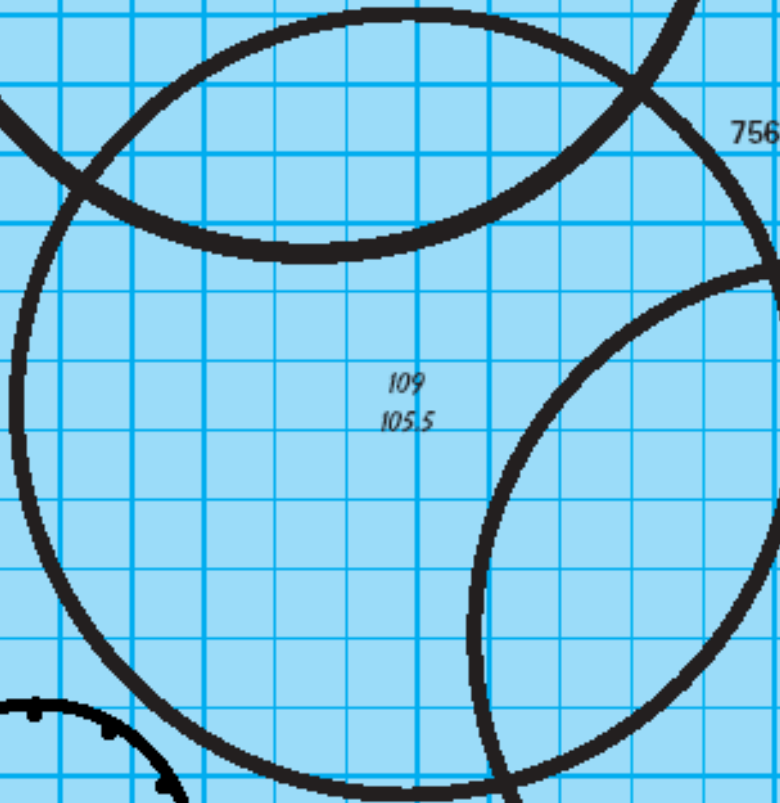

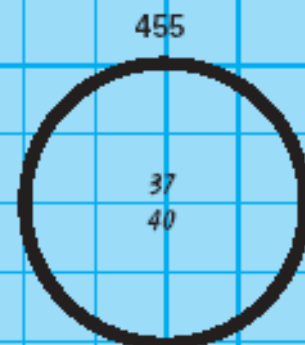
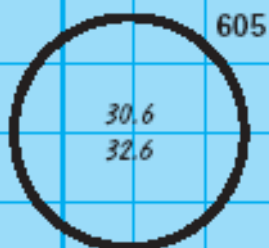
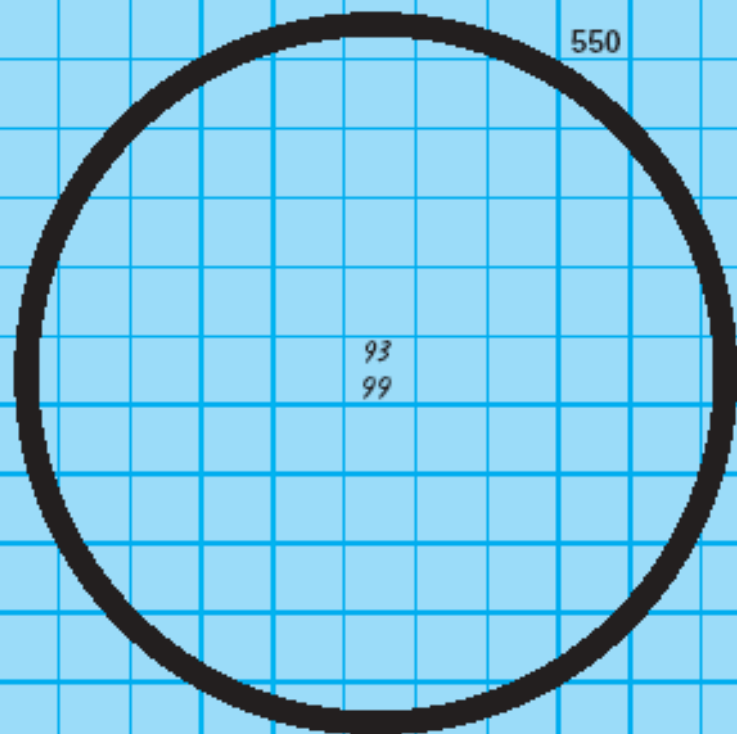
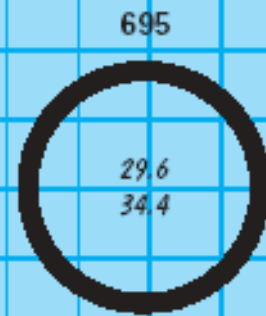
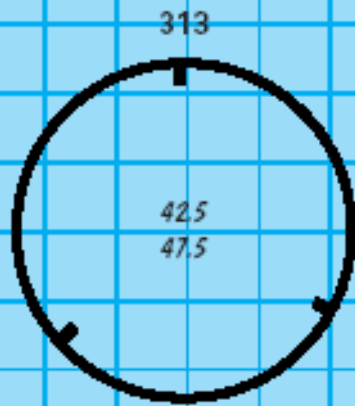

All tubes can be supplied at different I.D. for nominal charge.

1097



1054



011



1258



990



324



323/005

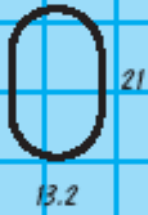

323

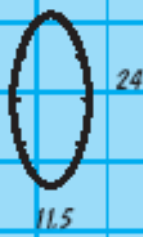

323



324/002



1040



311/021



311/008



1088



1066



1209



1037

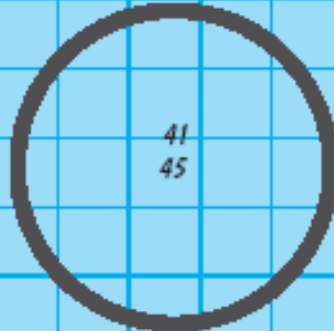

1209

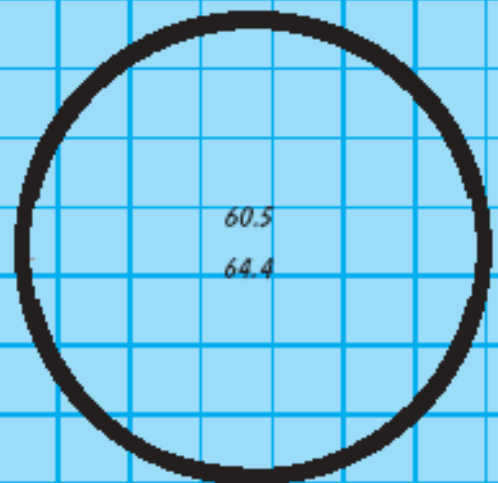

F33

○ 2.13
3.56

G27

○ 3.2
5.5

G30

○ 4.5
5.2

G23

○ 6
9

F39

○ 11
11.7

G25

○ 12.5
16.2

G19

○ 3.1
4.8

F51

○ 8
11

311/020

○ 12.5
17.5

G16

○ 7.5
10.1

G02

○ 2.8
5.25

G17

○ 4.75
6.75

G24

○ 3.7
5.4

G21

○ 5
7.5

G36

○ 4
5.5

G18

○ 6
9.25

F97

○ 8
10

G15

○ 7
10

All tubes can be supplied at different I.D. for nominal charge.

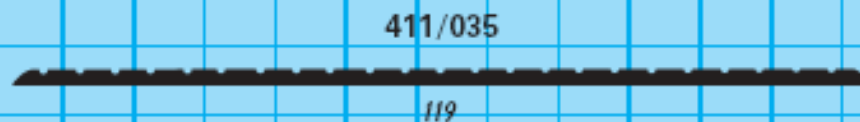
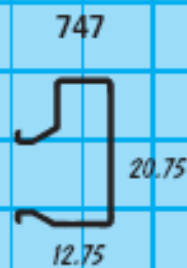
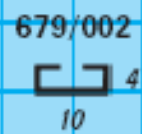
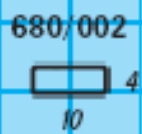
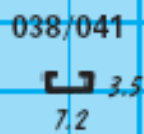
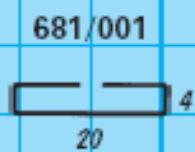
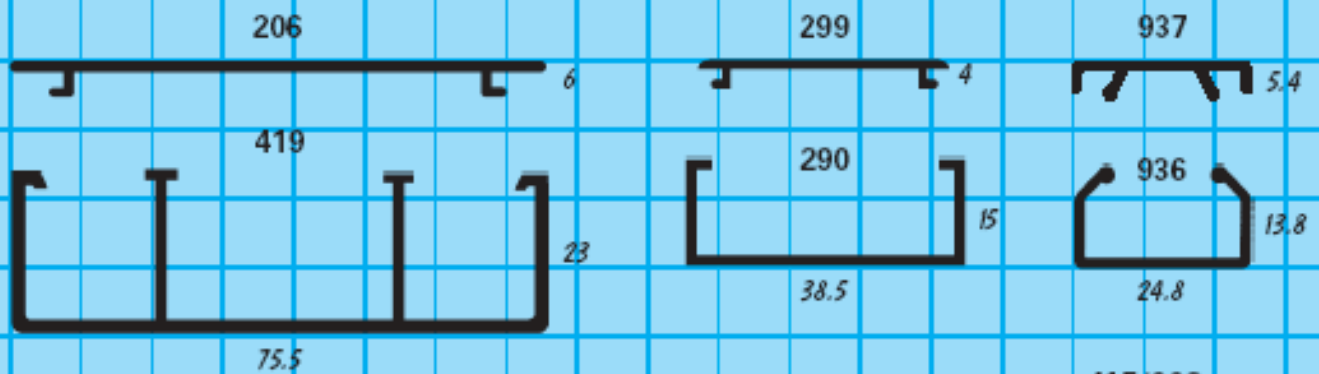

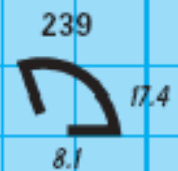
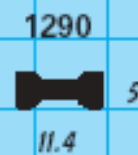
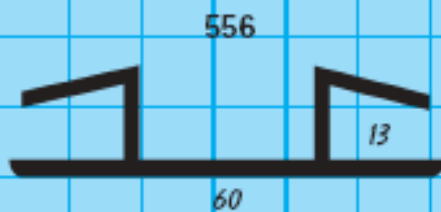
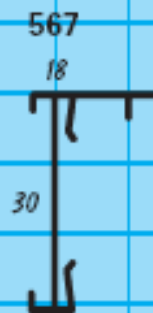
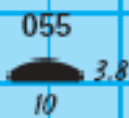
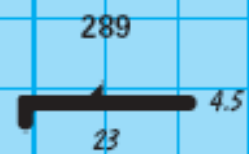
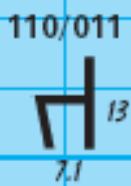
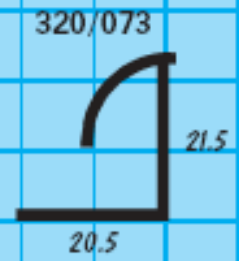
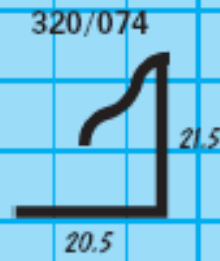
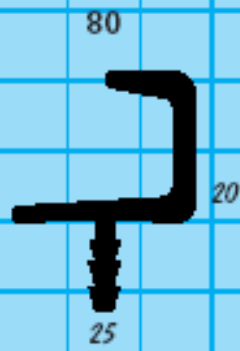

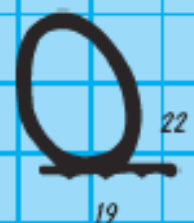
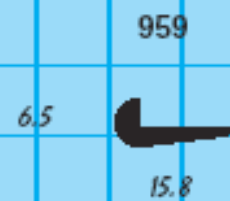
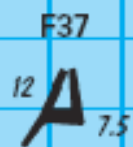
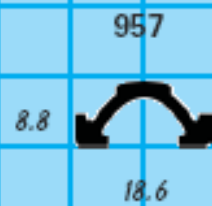
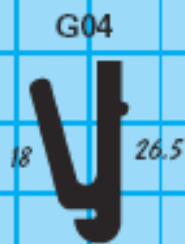
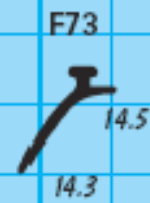
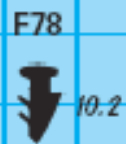

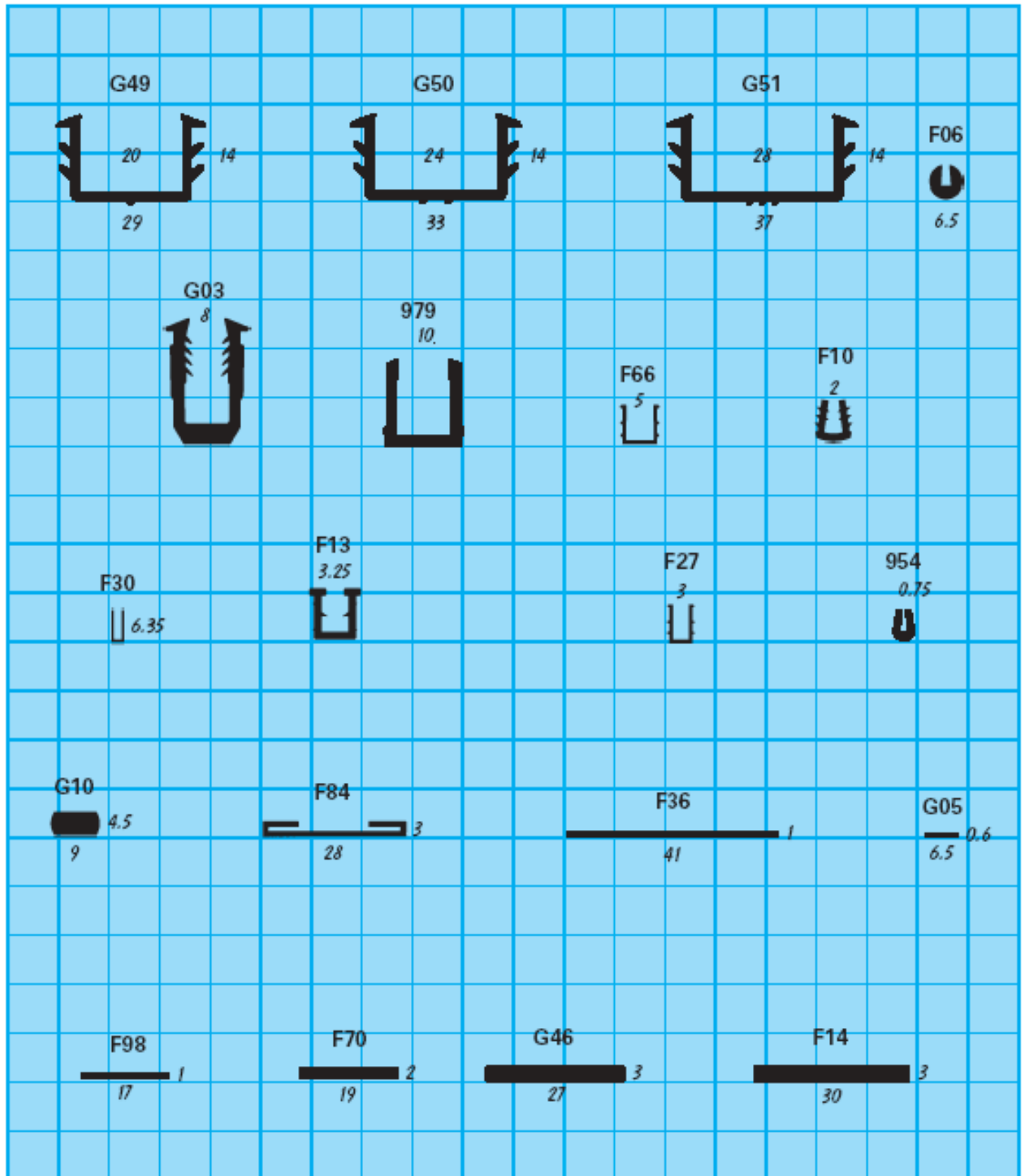

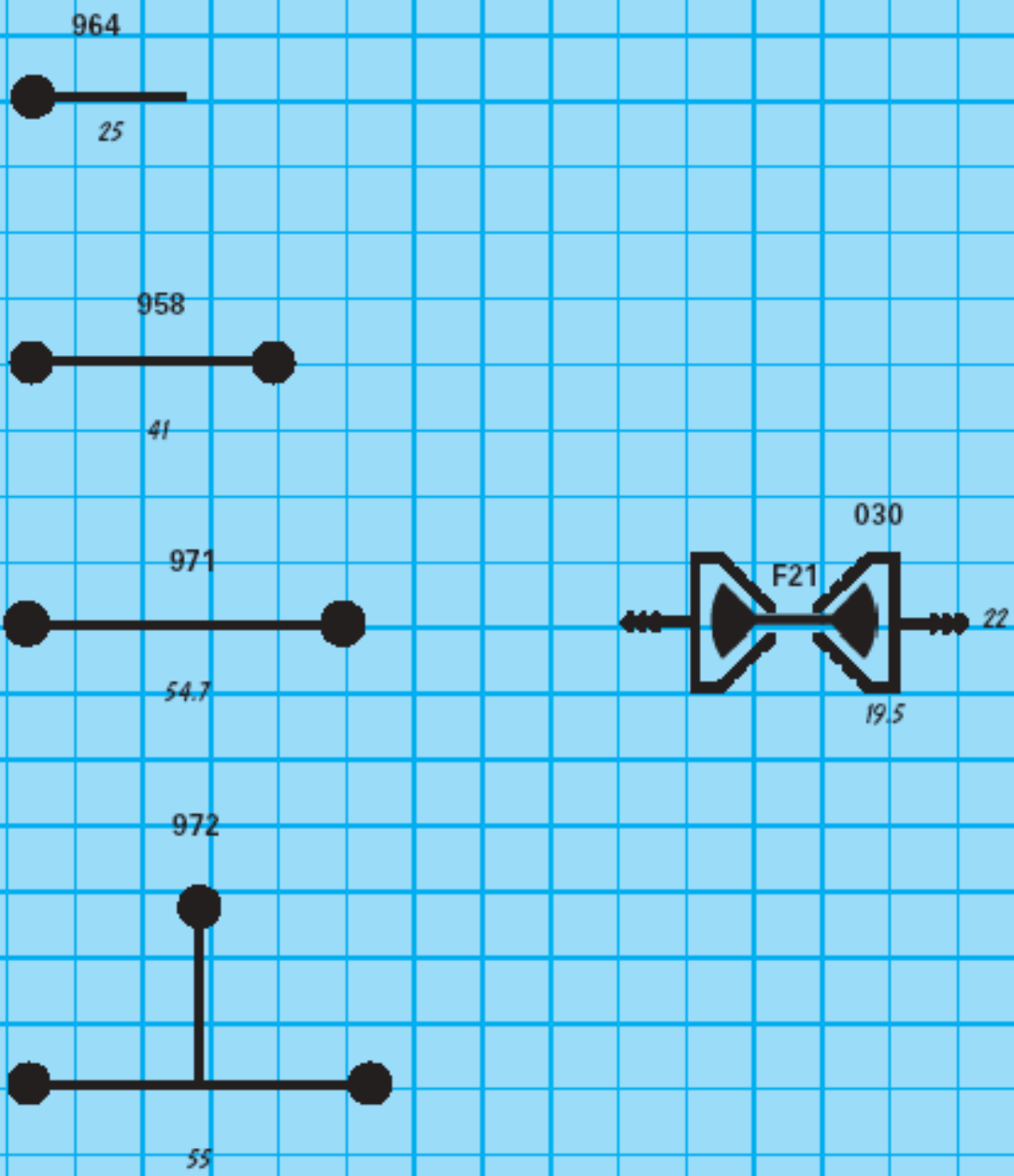

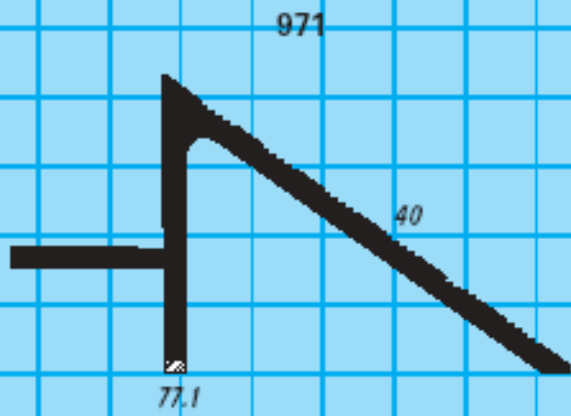
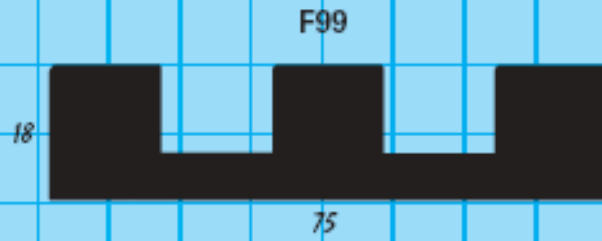

Denotes Flexible part of Dual Hardness Extrusions